



Loop-IP6704A TDMoEthernet



Description

The **Loop-IP6704A TDMoEthernet** is an ideal solution for service providers to build their network and achieve a fast return on investment. Currently providers need to transport both TDM and Packet traffic. These can be achieved using the E1/FE1, T1/FT1 and Gigabit Ethernet tributary ports of the IP6704A.

The Loop-IP6704A device allows operators to transport and **Time Slot Cross Connect** E1/FE1, T1/FT1, E&M, X.21, RS232, V.35, EIA530, QFXSA or QFXO, G.703, C37.94 data stream with timing information over PSN (Packet Switched Network) via Pseudowire Protocol – SAToP/CESoPSN/MEF8. Another IP6704A converts the received packet stream back to original E1/FE1, T1/FT1, E&M, X.21, RS232, V.35, EIA530, QFXSA or QFXO, G.703, C37.94 data stream with original timing information. This allows cost-effective migration from existing legacy TDM networks to existing PSN.

For transport of TDM signals, the Jitter and Wander adheres to G.823/G.824 Traffic Interface.

Product Features

Mechanical and Electrical

- 1U height, 1/2 19" rack width. ANSI shelf.
- Power module
 - Up to two DC plug-in modules or Hybrid 100 to 240 Vac and -48 Vdc (-36 to -72 Vdc) coexist fixed power supply
- Temperature range from 0° to 75°C

Ethernet Interface

- Four Ethernet ports for WAN or LAN port by software configuration
 - Two Gigabit Ethernet (GbE) with 2 SFP housing
 - Two 10/100/1000 BaseT Ethernet
- IEEE 802.3ad Ethernet Link Aggregation*

Timing

- Internal/Line
- Adaptive Clock Recovery for TDM Pseudowires
 - Jitter and Wander conforms to G.823/824 for Traffic Interface
- SyncE

Management

- SNMPv1/v3
- DB-9 Console port with VT-100 menu
- Telnet and SSH v2
- iNET GUI

L2 Switching

- VLAN
 - Maximum 4094 concurrent VLAN Groups
 - Support C-VLAN/S-VLAN tag adding and removing on Pseudowire

Tributary Interface

- Up to four T1/E1 ports per module with a max of 2 modules plus 2 T1/E1 on main board giving a maximum capacity of 10 T1/E1.
- Up to two single port DTE modules:
 - X.21 or RS232/V.24 or V.35 or EIA530
- Up to 2 voice modules:
 - Four ports E&M
 - Four ports FXS
 - Four ports FXO
 - Four ports Magneto
 - Supports Echo Cancellation

OAM

- E1/T1 OAM
 - RFC-2495: LOS, LOF, LCV*, RAI, AIS, FEBE*, BES, DM*, ES, SES, UAS and LOMF*

QoS

- Ingress Rate Limiting* per Ethernet port with 64kbps/1Mbps/10Mbps granularity
- Ethernet Network Level:
 - 3-bit Priority Code Point – PCP field within 802.1P/802.1Q Ethernet frame – CoS
 - 4 priority queues per port
- IP Network Level:
 - 6-bit DiffServ Code Point -DSCP field – ToS
- Scheduling Algorithm
 - Strict Priority (SP)
 - Weighted Round Robin (WRR)

Pseudowires

- TDM Pseudowires

- Support 802.1q Port-Based VLAN on Ethernet/SNMP Port
- Support 802.1d MAC Learning
- Support 803.3x Flow control* on input ports
- Support 802.1D STP, 802.1w RSTP, 802.1s MSTP*
- Support IGMP Snoopingv2 (RFC 2236)*
- Jumbo frame up to 10k bytes
- IS-IS Packet transparency*
- Up to 16 concurrent pseudowires
- 1 E1/T1 can support up to 16 pseudowires.
- Pseudowire protocols
 - SAToP
 - CESoPSN
 - MEF-8 (CESoETH)
- Packet Delay Variation Compensation Depth up to 256 ms

Diagnostics

- E1/T1 BERT & Loopback

Cross Connect Capability

- Support full non-blocking DS0 cross connect matrix between TDM interfaces and TDMoE Pseudowires
- Suitable for DACS (Digital Access Cross-Connect System) and ADCB (Add/Drop Channel Bank) applications
- Auto A-law/ μ -law conversion

* Future option

Model	IP6704A
# of fixed Mini-slots	2
Max. E1 Ports	10
Max. T1 Ports	10
Max. PWs	16
Cross-Connect Capacity	52 Mbps

Ordering Information

Note: RoHS compliant units are identified by the letter **G** appearing at the end of the ordering code.

Main Unit		
Model	Description	Note
Loop-IP6704A-S-PPM-aa-bb-c-c-dd-pp1-pp2- opt1-G	IP6704A with G.823/G.824 traffic interface, Two Gigabit Ethernet (GbE) with SFP housing Two 10/100/1000 BaseT Ethernet, 1 SNMP port	Where aa, bb, cc, dd, pp1, pp2 are manufacture options defined in tables below.
Loop-IP6704A-S-PPM-SyncE-DACS-aa-bb-cc-dd-pp1-pp2- G	Digital Access Cross-Connect System(DACS) IP6704A with G.823/G.824 traffic interface Support Synchronous Ethernet Two Gigabit Ethernet (GbE) with SFP housing Two 10/100/1000 BaseT Ethernet, 1 SNMP port	For E1, the capacity of DS0 cross connect: 10*E1 (32 DS0) + 16*PW =26*32 DS0. For T1, the capacity of DS0 cross connect: 10*T1 (24 DS0) + 16*PW =26*24 DS0. Where aa, bb, cc, dd, pp1, pp2 are manufacture options defined in tables below.

■ Where **aa** is used to select **E1/T1 Interface** on main board. If these modules are not required, leave this field blank.

aa =	Description	Notes
E75	E1 75 ohm with RJ48C connector	RJ48 to BNC conversion cable for E75 interface is not included. Please order conversion cable separately. Loop-ACC-CAB-RJ48M-28-2BNCF
E120	E1 120 ohm with RJ48C connector	
T1	T1 with RJ48C connector	

■ Where **bb** is used to select **E1/T1 Interface** on main board . If these modules are not required, leave this field blank.

bb =	Description	Notes
E75	E1 75 ohm with RJ48C connector	RJ48 to BNC conversion cable for E75 interface is not included. Please
E120	E1 120 ohm with RJ48C connector	

T1	T1 with RJ48C connector	order conversion cable separately. Loop-ACC-CAB-RJ48M-28-2BNCF
----	-------------------------	---

■ Where **cc** and **dd** are used to select **DTE, Voice, and E1/T1 Interfaces** on manufacturing option daughter board . If these modules are not required, leave these fields blank.

cc, dd =	Description	Notes
X21	X.21 interface module with DB15 female connector	
RS232	RS232/V.24 interface module with DB25 female connector.	
QEMA-wr-m-Tn-x	Quad E&M voice module, adapter cable included for 4 RJ45 connectors.	<ul style="list-style-type: none"> For wr, m, n and x option, please refer to the table below for detail information
QFXSA-x	Quad FXSA voice module	<ul style="list-style-type: none"> For x option, please refer to the table below for detail information
QFXSA-M-x	Quad FXSA with metering pulse 16KHz voice module	
QFXSA-M12-x	Quad FXSA with metering pulse 12KHz voice module	
QFXSA-GS-x	Quad FXSA with ground start voice module	
QFXSA-GM-x	Quad FXSA with ground start and metering pulse 16KHz voice module	
QFXO-x	Quad FXO voice module	
QFXO-M-x	Quad FXO with metering pulse 16KHz voice module	
QFXO-M12-x	Quad FXO with metering pulse 12KHz voice module	
QFXO-GS-x	Quad FXO with ground start voice module	
QFXO-GM-x	Quad FXO with ground start and metering pulse 16KHz voice module	
QMAGA-12-x*	Quad Magneto plug-in module w/ L1, L2	For x option, please refer to the table below for detail information
QMAGA-1G2-x*	Quad Magneto plug-in module w/ L1, L2, and L1. GND	
V35	V.35 interface module with DB25 female connector	
E530	EIA530 interface module with DB25 female connector	
T1	1 port T1 module	
E75	1 port E1 module (75 ohm with BNC connector)	
E120	1 port E1 module (120 ohm with RJ48 connector)	
M1C37-LSFOM	1- channel C37.94 interface module	
TS*	Terminal Server module	
ECA *	Echo cancellation module	
1ODP	1 OCU-DP interface module	
M4T1	Mini Quad T1 Interface	Includes a three meter conversion cable (Loop-ACC-CAB-DB25M-300-4RJ48M)
M4E75	Mini Quad E1 Interface with 75 ohm	Includes a three meter conversion cable (Loop-ACC-CAB-DB25M-300-8BNCM)
M4E120	Mini Quad E1 Interface with 120 ohm	Includes a three meter conversion cable (Loop-ACC-CAB-DB25M-300-4RJ48M)
CD	1-channel G.703 Interface at 64 Kbps data rate	

■ Where **pp1** is used to select **power module**. Must select one power module from the list below.

pp1=	Description	Notes
P9	Hybrid 100 to 240 Vac and -48 Vdc (-36 to -72 Vdc) coexist fixed power supply If customer wishes to use 125Vdc power supply, wire to included IEC socket which plugs into AC connector	<ul style="list-style-type: none"> Order two DC power modules for redundancy. For AC, choose an appropriate power cord. pp2 option is not available if P9 power module is selected in pp1 option. For 125 Vdc, wires are included with IEC socket. 
ISD48	Single -48Vdc power plug-in module (-42 to -56 Vdc)	

■ Where **pp2** is used to select **redundant DC power module**. Leave the field blank if redundant DC power module is not required, or fixed **SA** power module is selected in **pp1** option.

pp2=	Description	Notes
ISD48	Single -48Vdc power plug-in module (-42 to -56 Vdc)	<ul style="list-style-type: none"> Order two DC power modules for redundancy. pp2 option is not available if P9 power module is selected in pp1 option

- Where **opt1** is used to select **SyncE**. Leave the field blank if it is not required

opt1=	Description	Notes
SyncE	Support Synchronous Ethernet	

- Special order information for distributors. Where daughter card is used to select **DTE, Voice, and E1/T1 Interfaces**. Distributors can open the case and change the daughter card by themselves.

	Description	Notes
IP6704A-X21-G	X.21 interface module with DB15 female connector with 4 screws and panel.	
IP6704A-RS232-G	RS232/V.24 interface module with DB25 female connector. with 4 screws and panel.	
IP6704A-QEMA-wr-m-Tn-x-G	Quad E&M voice module, adapter cable included for 4 RJ45 connectors. with 4 screws and panel.	<ul style="list-style-type: none"> For wr, m, n and x option, please refer to the table below for detail information
IP6704A-QFXSA-x-G	Quad FXSA voice module. with 4 screws and panel.	<ul style="list-style-type: none"> For x option, please refer to the table below for detail information
IP6704A-QFXSA-M-x-G	Quad FXSA with metering pulse 16KHz voice module with 4 screws and panel.	
IP6704A-QFXSA-M12-x-G	Quad FXSA with metering pulse 12KHz voice module with 4 screws and panel.	
IP6704A-QFXSA-GS-x-G	Quad FXSA with ground start voice module with 4 screws and panel.	
IP6704A-QFXSA-GM-x-G	Quad FXSA with ground start and metering pulse 16KHz voice module with 4 screws and panel.	
IP6704A-QFXO-x-G	Quad FXO voice module with 4 screws and panel.	
IP6704A-QFXO-M-x-G	Quad FXO with metering pulse 16KHz voice module with 4 screws and panel.	
IP6704A-QFXO-M12-x-G	Quad FXO with metering pulse 12KHz voice module with 4 screws and panel.	
IP6704A-QFXO-GS-x-G	Quad FXO with ground start voice module with 4 screws and panel.	
IP6704A-QFXO-GM-x-G	Quad FXO with ground start and metering pulse 16KHz voice module with 4 screws and panel.	
IP6704A-QMAGA-12-x-G*	Quad Magneto plug-in module w/ L1, L2 with 4 screws and panel.	For x option, please refer to the table below for detail information
IP6704A-QMAGA-1G2-x-G*	Quad Magneto plug-in module w/ L1, L2, and L1. GND with 4 screws and panel.	
IP6704A-V35-G	V.35 interface module with DB25 female connector with 4 screws and panel.	
IP6704A-E530-G	EIA530 interface module with DB25 female connector with 4 screws and panel.	
IP6704A-T1-G	1 port T1 module with 4 screws and panel.	
IP6704A-E75-G	1 port E1 module (75 ohm with BNC connector) with 4 screws and panel.	
IP6704A-E120-G	1 port E1 module (120 ohm with RJ48 connector) with 4 screws and panel.	
IP6704A-M1C37-LSFOM-G	1- channel C37.94 interface module with 4 screws and panel.	For LSFOM option, please refer to the table below for detail information
IP6704A-TS-G*	Terminal Server module with 4 screws and panel.	
IP6704A-ECA-G*	Echo cancellation module with 4 screws and panel.	
IP6704A-1ODP	1 OCU-DP interface module with 4 screws and panel.	Only non-RoHS compliant model available
IP6704A-M4T1-G	Mini Quad E1 Interface with 4 screws and panel.	Limited Quantity Includes a three meter conversion cable (Loop-ACC-CAB-DB25M-300-4RJ48M)

	Description	Notes
IP6704A-M4E75-G	Mini Quad E1 Interface with 75 ohm with 4 screws and panel.	Includes a three meter conversion cable (Loop-ACC-CAB-DB25M-300-8BNCM)
IP6704A-M4E120-G	Mini Quad E1 Interface with 120 ohm with 4 screws and panel.	Includes a three meter conversion cable (Loop-ACC-CAB-DB25M-300-4RJ48M)
IP6704A-CD-G	1-channel G.703 Interface at 64 Kbps data rate with 4 screws and panel.	

For QEMA module:

■ where **wr** is used to select E&M wire type (manufacture option):

wr	Description	Notes
2w	2 wire	
4w	4 wire	

■ where **m** is used to select E&M signaling side (manufacture option):

m	Description	Notes
B	B (carrier side) connects to A side.	
A	A (exchange side) connects to B side. A side M lead to B side M lead, A side E lead to B side E lead.	

■ where **n** is used to select E&M signaling type (manufacture option):

n	Description	Notes
O	For voice transmission only.	• Circuit type does not matter.
1	Type I (original) E&M signaling circuit	• M lead provides discharge for the A side.
2	Type II circuit. This design attempts to reduce ground noise by adding two leads: SB (signal to battery) and SG (signal to ground).	• Reduced ground noise. Ground current is eliminated at the cost of two more wires per circuit.
3	Type III circuit. The SG lead serves as a discharge for the M lead. Reduces delay caused by combination of (a) low current electronic detectors, and (b) long runs of the E and M leads.	• Type III is area because ground currents on the E return would cause noise.
4	Type IV circuit. Based on the type II circuit. This E&M circuit provides symmetry.	
5	Type V circuit. For applications where ground noise is not an issue. Based on the type II circuit.	

For Voice modules (QEMA, QFXSA, QFXO):

■ where **x** is used to select Voice module signaling bits (manufacture option). If this option is not required, omit the **x** field in the ordering code.

Module Type	x =	Description	Notes
QEMA	E	Follows ETSI signaling bits	• For S (customer's special bit assignment), please contact your nearest Loop sales representative.
	A	Follows ANSI signaling bits	
	S	Follows customer's special bits assignment	
QFXSA	E	Follows ETSI signaling bits	
	A	Follows ANSI signaling bits	
	S	Follows customer's special bits assignment	
QFXO	E	Follows ETSI signaling bits	
	A	Follows ANSI signaling bits	
	S	Follows customer's special bits assignment	
	T	Trunk condition OFF-HOOK	
	AT	Follows ANSI signaling bits w/ trunk condition OFF-HOOK	
	ST	Follows customer's special bits assignment w/ trunk condition OFF-HOOK	

For Magneto Card:

■ Where **x** is used to select ring generator type:

x=	Description	Note
16	16 Hz ring generator	20 Hz is the general setting for all MAG cards. For special settings (16, 25, 50), please specify your need by filling in the x option.
20	20 Hz ring generator	
25	25 Hz ring generator	
50	50 Hz ring generator	

For mini LS Optical module (mini C37.94):

■ Where **LSFOM** is to select **LS-Fiber Optical Module** option, each module has 5 letters.

LSFOM	Description										Notes
	Mode		Data Rate		Wave Length		Distance		Connector		
Code	Code	Description	Code	Description	Code	Description	Code	Description	Code	Description	
ZRATT	Z	1 * 8 Multi-mode	R	2 M	A	820nm	T	2km	T	ST connector	1 * 8 Separate transceiver & receiver
QRATT	Q	1 * 9 Multi-mode	R	2 M	A	850nm	T	2km	T	ST connector	1 * 9
*NFB3T	N	1 x 9 Single mode	F	125 M	B	1310nm	3	30km	T	ST connector	
*QFBTT	Q	1 x 9 Multi-mode	F	125 M	B	1310nm	T	2km	T	ST connector	
*NHC2S	N	1 x 9 Single mode	H	155 M	C	1550nm	2	20km	S	SC connector	

* For the orders of the listed optical modules, please contact your Loop sales representative.

Accessories

Power Cord (All power cords are RoHS compliant)

Loop-ACC-PC-USA	AC power cord for Taiwan/America	
Loop-ACC-PC-EU	AC power cord for Europe	
Loop-ACC-PC-UK	AC power cord for UK	
Loop-ACC-PC-AUS	AC power cord for Australia	
Loop-ACC-PC-CH	AC power cord for China	

Tray

81.TRAY19.0000G	1U 19" Tray for rack mount (One tray for two base units; Tray depth:17cm) 23" Extension kit for 23" rack mount
81.TRAY19.3000G	1U 19" Tray for rack mount (One tray for two base units; Tray depth:40cm) 23" Extension kit for 23" rack mount

Blank Panels

30.002378.A00LF	Blank panel for empty DC power slot
-----------------	-------------------------------------

Conversion Panels

Loop-ACC-P-4RJ45F-4WW-G	4 ports RJ45 Females to 4 ports wire-wraps for QEMA module.
-------------------------	---

Cable (All Cables are RoHS compliant.)

Loop-ACC-CAB-DB25M-30-1M34F*	DB25 Male to M34 Female Conversion cable for V.35 module. Length: 30 cm
Loop-ACC-CAB-RJ48M-28-2BNCF	RJ48C Male to two BNC Female Conversion cable for E1 75ohm module. Length: 28 cm
Loop-ACC-CAB-DB44M-100-2DB25F-1DB09F-TS*	DB44 Male to two DB25 Female and one DB9 Female conversion cable for Terminal server module. Length: 100 cm
Loop-ACC-CAB-DB44M-60-4RJ45M	DSUB-44pin/Male to RJ45 Male (8P8C) Plug * 4 extension cable for QEMA module. Length: 60 cm
Loop-ACC-CAB-DB25M-100-8BNCF	DB25/Male to eight BNC/Male cable; Length: 100 cm For Mini Quad E1 Interface with 75 ohm
Loop-ACC-CAB-DB25M-100-8BNCF	DB25/Male to eight BNC/Female cable; Length: 100 cm For Mini Quad E1 Interface with 75 ohm
Loop-ACC-CAB-DB25M-100-4RJ48M	DB25/Male to four RJ48C/Male (8P8C Plug) cable; Length: 100 cm Mini Quad E1 Interface with 120 ohm

Loop-ACC-CAB-DB25M-300-8BNCM	DB25/Male to eight BNC/Male cable; Length: 300 cm For Mini Quad E1 Interface with 75 ohm
Loop-ACC-CAB-DB25M-300-8BNCF	DB25/Male to eight BNC/Female cable; Length: 300 cm For Mini Quad E1 Interface with 75 ohm
Loop-ACC-CAB-DB25M-300-4RJ48M	DB25/Male to four RJ48C/Male (8P8C Plug) cable; Length: 300 cm Mini Quad E1 Interface with 120 ohm and Mini Quad T1 Interface

User's Manual		
Loop-IP6704A-UM	User's Manual (optional, paper printed copy). An electronic version of the manual on a CD is included with every order.	
Loop-IP6704A-DACS-UM	User's Manual (optional, paper printed copy). An electronic version of the manual on a CD is included with every order. For Loop-IP6704A-S-PPM-SyncE-DACS-aa-bb-cc-dd-pp1-pp2- G use only.	
SFP Optical Modules		
Please place your order using the 5-digit alphanumeric codes listed in the separate SFP Optical Module Brochure. Note: Non-Loop SFP modules are not guaranteed to work with our equipments. It is strongly recommended to buy Loop- logo SFP modules.		
Separate Power Module		
Loop-IP6704A-ISD48- G	Single -48Vdc power plug-in module (-42 to -56 Vdc)	<ul style="list-style-type: none"> Power modules are the same as shown in the Main Unit section above. Use this ordering code if you are ordering backup or additional power modules. ISD48 power module can't work on IP6704A with fixed P9 power module.

Ordering Examples

Example 1:

Loop-IP6704A-S-PPM-X21-P9-**G**

IP6704A with G.823/G.824 traffic interface, Two Gigabit Ethernet (GbE) with SFP housing, Two 10/100/1000 BaseT Ethernet, one SNMP port, 1 x X.21 interface with DB15 female connector, Hybrid 100 to 240 Vac and -48 Vdc (-36 to -72 Vdc) coexist fixed power supply

Example 2:

Loop-IP6704A-S-PPM-E75-RS232-ISD48-ISD48-**G**

IP6704A with G.823/G.824 traffic interface, Two Gigabit Ethernet (GbE) with SFP housing, Two 10/100/1000 BaseT Ethernet, one SNMP port, 1 x E1 75 ohm with RJ48C connector, 1 x RS232/V.24 with DB25 female connector, two -48Vdc power plug-in module (-42 to -56 Vdc).

Loop-IP6704A Product Specification

E1 Tributary Interface Module

Line Rate	2.048 Mbps ± 50 ppm
Line Code	HDB3 / AMI
Framing	ITU G.704 (CRC: on/off, CAS: on/off, unframed)
Output Signal	ITU G.703
Input Signal	ITU G.703
Jitter	ITU G.823
Connector	RJ48C

T1 Tributary Interface Module

Line Rate	1.544 Mbps ± 32 ppm
Line Code	AMI / B8ZS
Framing	D4 / ESF/ ESF&T1.403/ OFF (clear channel)
Output Signal	DS1
Input Signal	DS1
Pulse Template	Per AT&T TR 62411
Connector	RJ48C

Ethernet Interface (on board)

Number of Electrical Ports	2 ports with RJ45
Speed	10/100/1000 BaseT
Number of Optical Ports	2
Connector	SFP

Speed

100/1000-LX

Serial Tributary Interface

Type1 DCE, V.35 or EIA530 or X.21

Line Rate: Sync mode: V.35, EIA530 and X.21 N x 56 or 64 kbps, N = 1 to 32

Interface/ Connector: V.35 DB25S

EIA530 DB25S

X.21 DB15S

Type2 DCE, RS232/V.24

Line Rate: Sync mode: RS232: N x 56 or 64 kbps, N = 1 to 2

Interface/ Connector: RS232/V.24 DB25S

Voice Card (QEMA)

Connector	One 44-pin connector, adaptor cable included for 4 RJ45 connectors.
Alarm Conditioning	CGA busy after 2.5 seconds of LOS, LOF
Encoding	A-law or μ -law, user selectable as a group
Impedance	Balanced 600 or 900ohms
Gain Adjustment (Per-port setting)	-10 to +7 dB / 0.1dB step for transmit (D/A) gain
Gain Variation	± 0.5 dB at 0 dBm0 input
Frequency Response	± 0.5 dB from 300 to 3400 Hz, coincide with ITU-T G.712
I/O Power Range	A/D Analog input level: -66 dBm (0.00039 Vrms) ~ + 3 dBm (1.09 Vrms) D/A Analog output level: -66 dBm (0.00039 Vrms) ~ + 4 dBm (1.22 Vrms)
Longitudinal Balance	> 63dB
Longitudinal Conversion Loss	> 46dB
Total Distortion	> 35 dB at 0 dBm0 input
Idle Channel Noise	< -65 dBm0p
Wire Mode	2 wire and 4 wire
Signaling	Type I, Type II, Type III, Type IV, Type V, and TO (Transmission Only)
M Lead Output Current	18 mA (maximum)
E Lead Sensor Current	0.3 mA (minimum)
EM Type Setting	Jump Selectable
Relative Humidity	0% to 95%
Carrier Connection	Side A and side B setup by Jump

All in-band signaling tones are carried transparently by the digitizing process.

Customer is responsible for in-band signaling compatibility between a telephone and a switch, or between a PBX and a switch.

Voice Card (QFXO)

Quad FXO voice card (4 FXO per plug-in)

Connector	1, 2, 3, or 4 FXO per RJ11 connector
Alarm Conditioning	CGA busy after 2.5 seconds of LOS, LOF
Encoding	A-law or μ -law, user selectable together for all
AC impedance	Balanced 600 or 900 ohms (selectable together for all)
Longitudinal Rejection	55 dB
Loss Adjustment	0, 3, 6, or 9 dB transmit & receive
Signal/ Distortion	1. > 46dB with 1004 Hz, 0dBm input
Frequency Response	2. ± 0.5 dB from 300 to 3400 Hz, coincide with ITU-T G.712
FXS Loop Feed	-48Vdc with 25mA current limit per port Jumper Selectable: 25mA, 30mA, 35mA
FXO	Ringing REN 0.5B (AC) Detectable Ringing 25 Vrms Loop Resistance $\leq 1800 \Omega$ DC impedance (ON-HOOK) > 1M Ω DC impedance(OFF-HOOK) 235 Ω @ 25mA feed 90 Ω @ 100mA feed
FXS Ringing	Support 2 REN per port (1 REN = 6930 Ω + 8 μ F) 20 Hz, other frequencies: 16.7Hz, 25 Hz, 50Hz (Jump selectable) 78 Vrms (sine wave) (45 Vrms to 86 Vrms wide range by Resistor selectable) 2 sec on 4 sec off, or 1 sec on 2 sec off optional for PLAR
Metering Pulse	12KHz/ 16KHz • Power: 10dBm • Sensitivity: -27dBm (-21dBm to -45dBm by Resistor selectable)
Signaling	Loop Start, GND-Start, Metering Pulse (12KHz, 16KHz), DTMF, Dialing Pulse, PLAR, Battery Reverse (supports Line Reverse Signaling for Billing)

- All in-band signaling tones are carried transparently by the digitizing process.
- Customer is responsible for in-band signaling compatibility between a telephone and a switch, or between a PBX and a switch.

Voice Card (QFXSA)

Quad FXSA voice card (4 FXS per plug-in)

Connector 1, 2, 3, or 4 FXS per RJ11 connector

Alarm Conditioning CGA busy after 2.5 seconds of LOS, LOF

Encoding A-law or μ -law, user selectable

AC impedance Balanced 600 or 900 ohms (user selectable)

Longitudinal Rejection 55 dB

Gain Adjustment -21 to +3 dB / 0.1 dB step for transmit (D/A) & receive (A/D) gain

Signal/ Distortion > 46dB with 1004 Hz, 0dBm input

Frequency Response \pm 0.5 dB from 300 to 3400 Hz, coincide with ITU-T G.712Loop Feed \pm 48Vdc with 25mA current limit per port

Jumper Selectable: 25mA, 30mA, 35mA

Ringing Support 2 REN per port (1 REN = 6930 Ω + 8 μ F)

16.7Hz, 20Hz, 25 Hz, 50Hz (user programmable)

Default 78 Vrms (sine wave) (64 Vrms by Jumper setting)

2 sec on 4 sec off, or 1 sec on 2 sec off optional for PLAR (user programmable)

Metering Pulse 12KHz/ 16KHz (2.4Vrm/1Vrm user programmable)

Signaling Loop Start (Metering Pulse, DTMF, Dialing Pulse, PLAR), GND-Start (Tip Open, Ring GND), OOS Alarm, Battery Reverse

- All in-band signaling tones are carried transparently by the digitizing process.
- Customer is responsible for in-band signaling compatibility between a telephone and a switch, or between a PBX and a switch.

C37.94 Interface**820nm****Ordering Code**

ZRATT

Wavelength (nm)

820

Mode

1*8 Multi-Mode

Distance (km)

2

Data Rate (Mb/s)

2.048Mbps

Connector

ST

TX Power (dBm Peak)				RX Power (dBm Peak)				Note
MIN.	TYP.	MAX.	Wavelength	MIN.	TYP.	MAX.	Wavelength	
-19.8	---	-12.8	792/820/865	---	---	---	---	50/125 μ m Fiber Cable
-16	---	-9		---	---	---	---	62.5/125 μ m Fiber Cable
---	---	---	---	-25.4	---	-9.2	792/820/865	Peak Optical Input Power Logic Level LOW

850nm**Ordering Code**

QRATT

Wavelength (nm)

850

Mode

1*9 Multi-Mode

Distance (km)

2

Data Rate (Mb/s)

2.048Mbps

Connector

ST

TX Power (dBm Peak)				RX Power (dBm Peak)				Note
MIN.	TYP.	MAX.	Wavelength	MIN.	TYP.	MAX.	Wavelength	
-23	---	-11	790/---/870	-32	---	-11	790/---/870	50/125 μ m Fiber Cable
-19	---	-11		-32	---	-11	---	62.5/125 μ m Fiber Cable

1310nm**Ordering Code**

NFB3T

Wavelength (nm)

1310

Mode

1*9 Single-Mode

Distance (km)

30

Data Rate (Mb/s)

125Mbps

Connector

ST

TX Power (dBm)				RX Power (dBm)			
MIN.	TYP.	MAX.	Wavelength	MIN.	TYP.	MAX.	Wavelength
-15	---	-8	1261/1310/1360	-34	---	0	1260/---/1610

1310nm**Ordering Code**

QFBTT

Wavelength (nm)

1310

Mode

1*9 Multi-Mode

Distance (km)

2

Data Rate (Mb/s)

125M

Connector

ST

TX Power (dBm)				RX Power (dBm)				Note
MIN.	TYP.	MAX.	Wavelength	MIN.	TYP.	MAX.	Wavelength	
-20	---	-14	1270/1310/1380	-32	---	8	1260/---/1610	Output Optical Power 62.5/125 μ m fiber
-23.5								Output Optical Power 50/125 μ m fiber

1550nm**Ordering Code**

NHC2S

Wavelength (nm)

1550

Mode

1*9 Single-Mode

Distance (km)

20

Data Rate (Mb/s)

155Mbps

Connector

SC

TX Power (dBm)				RX Power (dBm)			
MIN.	TYP.	MAX.	Wavelength	MIN.	TYP.	MAX.	Wavelength
-15	---	-18	1480/1530/1576	-34	---	0	1260/---/1610

Network Line Interface Mini Quad E1

Line Rate	2.048 Mbps \pm 50 ppm	Framing	ITU G.704
Line Code	AMI or HDB3	Connector	DB25S
Input Signal	ITU G.703 to -10dB	Electrical	75 ohm Coax/120 ohm twisted pair
Output Signal	ITU G.703	Jitter	ITU G.823
Performance Store	Last 24 hours performance in 15-minute intervals and last 7 days in 24-hour summary line, user, and remote site		
Performance Reports	Date & Time, Errored Second, Degraded Minutes, Unavailable Second, Bursty Errored Second, Severe Errored Second, Controlled Slip Second, and Loss of Frame Count		
Alarm History	Date & Time, Alarm Type (i.e. Master Clock Loss, RAI, AIS, LOS, BPV, ES, CS), and Location (i.e. line, DTE)		
Alarm Queue	Alarm records which record the latest alarm type, location, and date & time		
Threshold	Bursty Seconds, Severely Errored Second, Degraded Minutes		

Network Line Interface Mini Quad T1

Line Rate	1.544 Mbps \pm 32 ppm	Framing	D4/ESF
Line Code	AMI/B8ZS	Connector	DB25S
Input Signal	ITU G.703 DSX-1 0dB to -30dB w/ALBO	Output Signal	ITU G.703 DSX-1 w/0, -7.5, -15dB LBO ITU G.703 DSX-1 w/short (0-110, 110-220, 220-330, 330-440, 440-550, 550-660 feet)
Jitter	AT&T TR 62411	Pulse Template	AT&T TR 62411
Data Rate	n * (64) Kbps (n=1-24)		
Performance Store	Last 24 hours performance in 15-minute intervals and last 7 days in 24-hour summary line, user, and remote site		
Performance Reports	Errored Second, Unavailable Second, Bursty Errored Second, Severe Errored Second, Controlled Slip Second, and Loss of Frame Count		
Alarm History	Date & Time, Alarm Type (i.e. RAI, AIS, LOS, BPV, ES, CS), and Location (i.e. line, DTE)		
Alarm Queue	Alarm records which record the latest alarm type, date and time		
Threshold	Error Second, Severe Errored Second, Unavailable Seconds, and Control Slip Seconds		

OCU/DP Interface

Ports	1 Port for each card
Line Status Indicator	Per Port 1 dual color LED; Red for LOS, Green for SYNC

Network Connector	RJ48S or Telco64
Electrical network connection	Tip/Ring and Tip1/Ring1
Transmit Source Impedance	135 Ohms +/- 20%
Receive Input Impedance	135 Ohms +/- 20%
Receiver Sensitivity/ Dynamic Range	0 to 43 dB loop loss at 72K & 56K 0 to 34 all other rates Automatic line equalization
Pulse Amplitude	+/- 1.5 V (+/- 10%) peak, all rates except 9.6k +/- 0.75 V (+/- 10%) peak at 9.6k Bipolar Return to zero, 50% duty cycle
Sealing Current	Typically 16 mA DC
Operating Modes	4-wire DDS Switched 56 support is optional.
Circuit Rates	SYNC: 2.4, 4.8, 9.6, 19.2, 56, 72kbps (64k) clear channel Conforms with AT&T Pub 41458
Encoding and decoding rules	Use bipolar violation to indicate control information: Idle, out of service, Zero substitution using unframed loops
Maintenance control	DSU Non-latching loop-back code (for 2.4, 4.8, 9.6, 19.2, 56k circuit rate) DSU Latching loop-back (TIP, LSC, LBE, FEV) code (for 72k circuit rate) Machine maintenance OCU/DP card operation: Payload loopback OCU loopback Local loopback Bi-directional loopback V.54 remote loopback code
Fault and Performance	Custom defined remote loopback code BERT test supports all ones, all zeros, 2047,511,63 pattern. LOS, OOS, ES, SES and UAS alarm. Current, last 96 registry and 7 days performance storage.
Environment	Operating Temperature: -20 - 65°C Storage Temperature: -30 - 70°C Humidity: Up to 90% RH non-condensing
Specification Standard	ANSI T1.410; AT&T Pub 62319, AT&T Pub 62310, ITU-T V.54

Management and Administration

Management ports	Console RS232 port and and NMS RJ45 port
Remote login	SSH v2, Telnet
SNMP	SNMP v1, v3
Support RADIUS checking login.	

Electrical

ISD48 Power Module	48 V (-42 to -56 Vdc)
P9 Power Module	Hybrid 100 to 240 Vac and -48 Vdc (-36 to -72 Vdc) coexist fixed power supply
SD125 Power Module*	Single 125Vdc power plug-in module
Power Consumption	< 15 W for 1U height

Physical and Environmental

Dimensions(W x H x D)	213 mm x 41 mm x 290 mm (8.39" x 1.61" x 11.42")
Temperature	0°C to +75°C
Humidity	0% to 95% RH (non-condensing)
Mounting	Desktop stackable, rack mount, wall mount
Cooling	It is fanless unit

Standards Compliance

IEEE		IETF	
802.1d	MAC Table Learning and STP	RFC2236	IGMP Snooping v2*
802.1p	Priority Code Point		
802.1q	VLAN	RFC2495	E1/T1 OAM*

802.1s	MSTP*		
802.1w	RSTP		
802.1ad	Tag Stacking (Q-in-Q)	RFC 4553	SAToP
802.3ad	Link Aggregation*	RFC 5086	CESoPSN
		ITU	
MEF		G.823/G.824	Traffic Interface
8	CESoETH		

Certifications

EMC EN5022 Class A, EN50024, FCC Part 15 Subpart B Class A,
 Safety EN60950-1(CE), IEC 61850-3* only Compliance on power module ISD48 -48Vdc.

* Future option

Panel Views

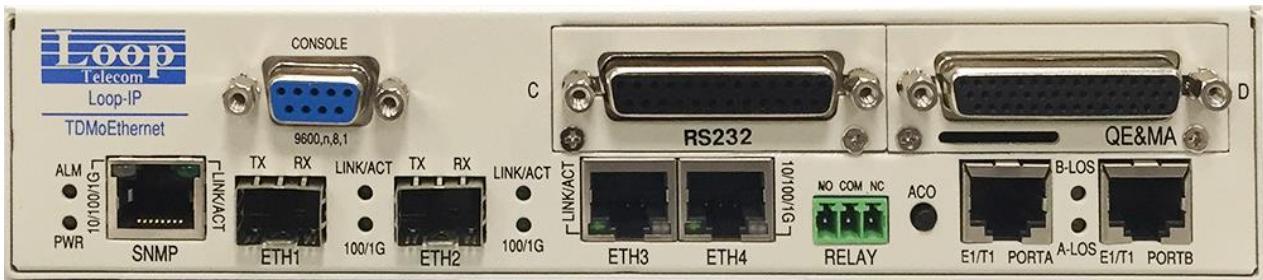

Front Panel View with 2 X E1/T1, 1 x RS232, 1 x QE&MA Tributary

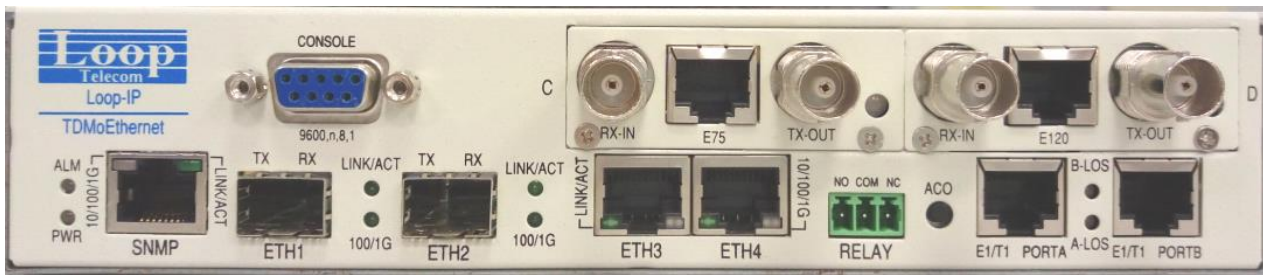

Front Panel View with 2 X E1/T1, 2 FE1 Tributary

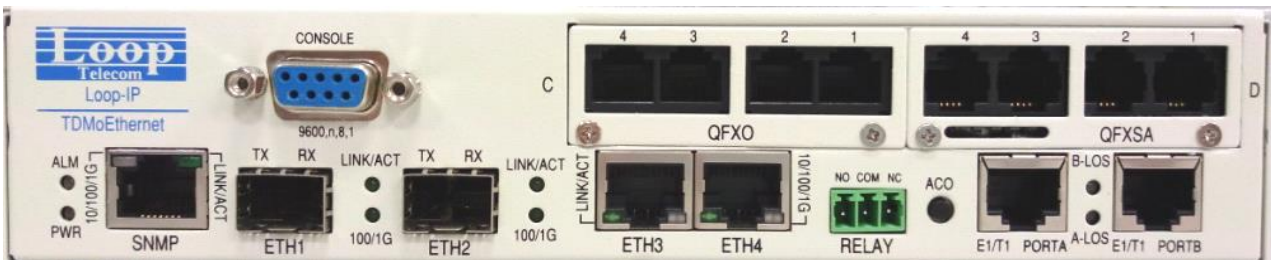

Front Panel View with QFXO & QFXSA Tributary



Rear Panel View with DC plug-in Power modules



Rear Panel View with P9 Power

Application Illustrations

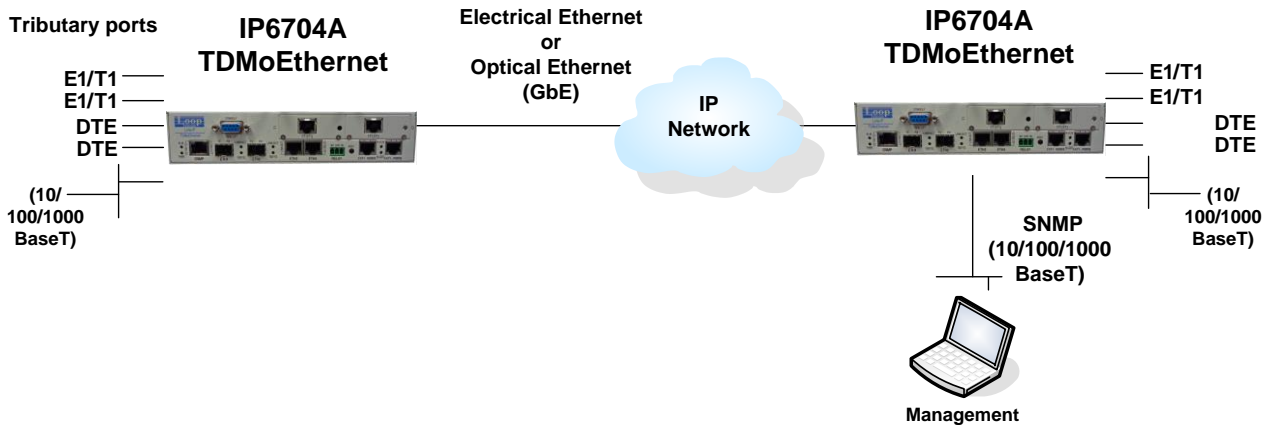

IP6704A Point-to-Point Application.

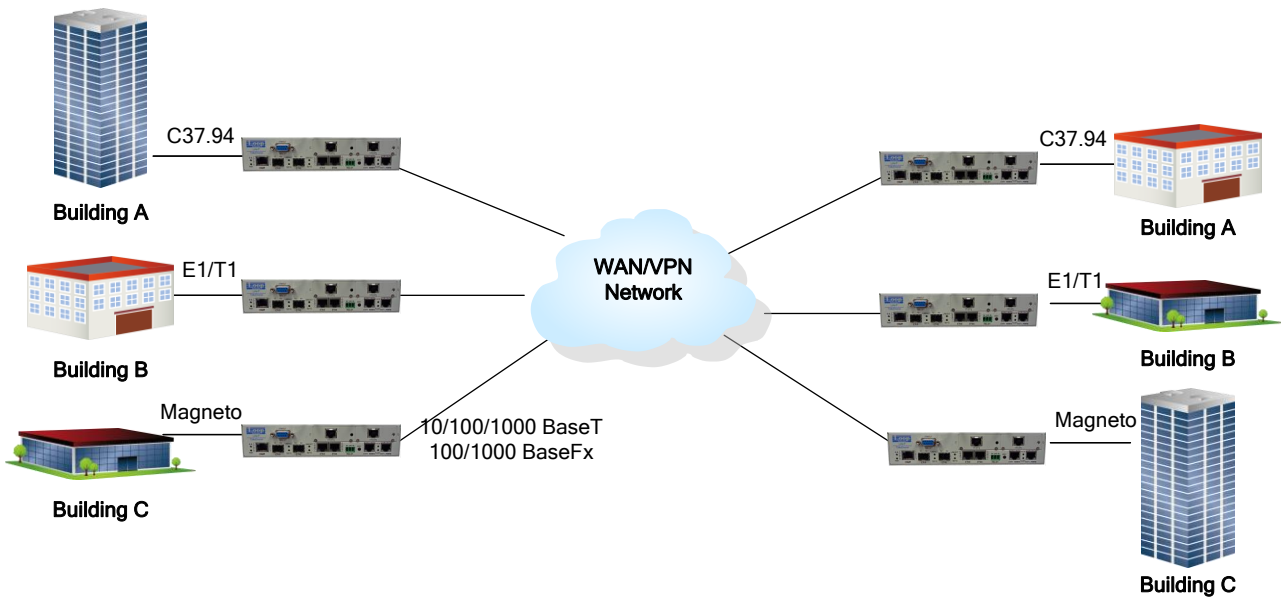

IP6704A on VPN Network

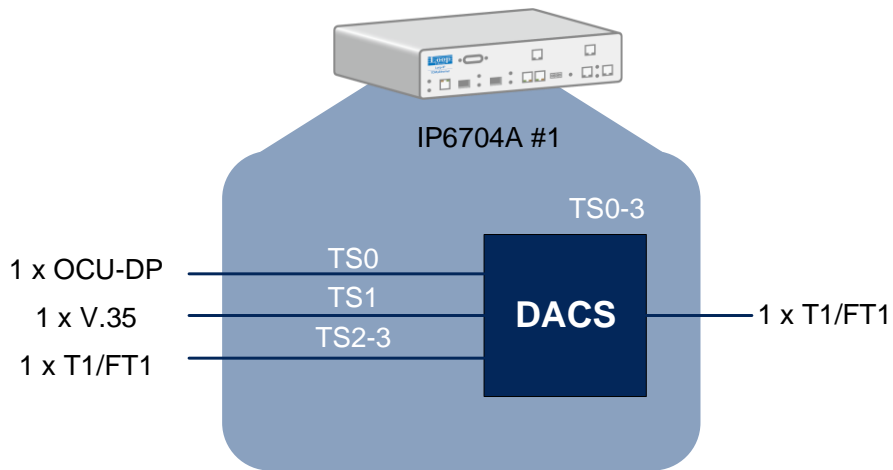

IP6704A on Digital Access Cross-Connect System (DACS)



Data Comm for Business, Inc.
2949 CR 1000 E
Dewey, IL 61840
Voice 8004DCBNET (800.432.2638)
Fax 217.897.8023
Info www.dcbnet.com/contact.html
Web www.dcbnet.com